

# PRECISION MOVEMENT MAXIMUM MANOEUVRABILITY

DELIVERING THE STRENGTH AND DURABILITY FOR  
BETTER CONTROL OVER HEAVY EQUIPMENT

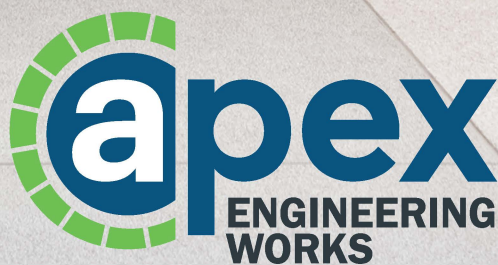

An ISO 9001:2015 Certified company

India's Leading Manufacturer & Exporter Of Steel Cable Drums

# ABOUT US



We design and develop a wide range of process steel drums that are durable in quality and long lasting. Our team of engineers has made these products from superior quality steel that is tried and tested at our quality testing unit for its features. These process steel drums are used as packaging material for heavy power cables.

- I Leading provider of a complete range of Steel Reel under one roof
- I Offering custom made products to a range of industries
- I Seamless product construction that is built to last
- I Products assembly through semi-automatic machinery
- I Static and dynamic

We are manufacturer of steel cable reels, assorted timber joinery products such as wooden cable reels, wooden pallets. Our pioneering spirit and passion for craftsmanship drives our market orientation and innovation. Our CAN DO! values of Credibility, Adaptability, Nurturing, Diversity and Openness provide the foundation for how we behave and do business. Growth for us is not just about getting bigger. Growth is also about showing greatness. We pride ourselves on being a family business that will grow through the generations. We aspire to build the best products in the most sustainable manner. And we hope to bring out the best in our people and inspire others to do the same. Our vision is to become a sustainable role model company that creates positive impact to People and Place.



# STEEL REELS

## Corrugated Packing Steel Reel



Mild Steel



Flange Ø 1,000mm to 3,600mm



Cable and wire rope packing. The simplified design allows for more economical pricing

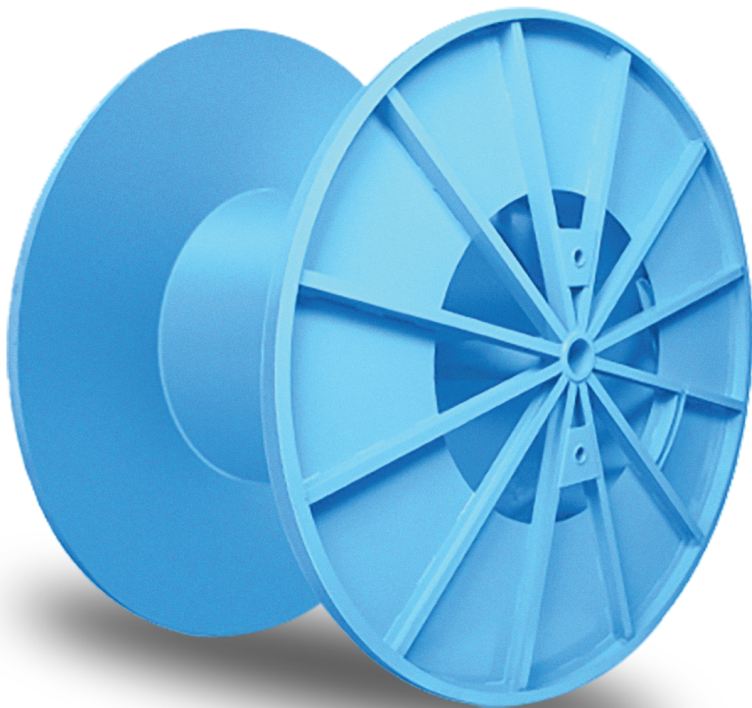
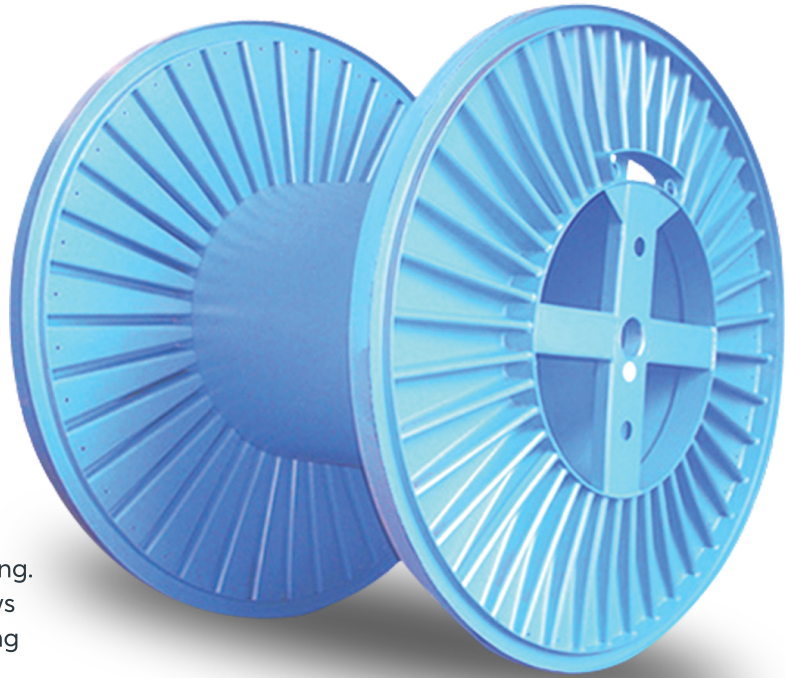

## Flat Process Steel Reel



Mild Steel



Flange Ø 1,000mm to 4,000mm



In-house process for cable and wire rope packing

# ADVANTAGES

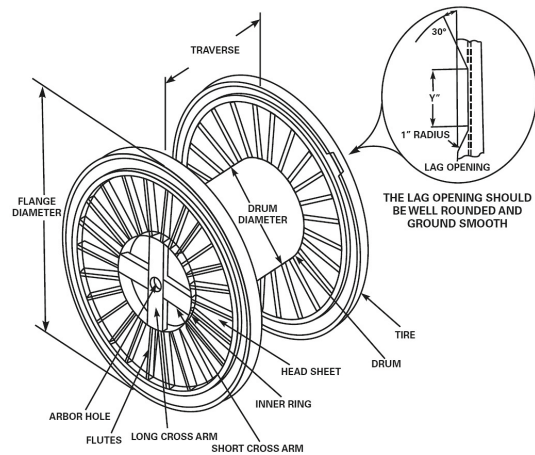

## Advantages of Steel Drums

- ▶ Steel cable drums are Eco friendly, wood free.
- ▶ There is no damage or harm is caused to nature
- ▶ Steel cable drum can be used more than one time as compared to wooden drums.
- ▶ Desired quality and finish can be achieve in steel reels as comapre to wooden drum.
- ▶ Higher reliability, better strength and more durability than wooden drum.

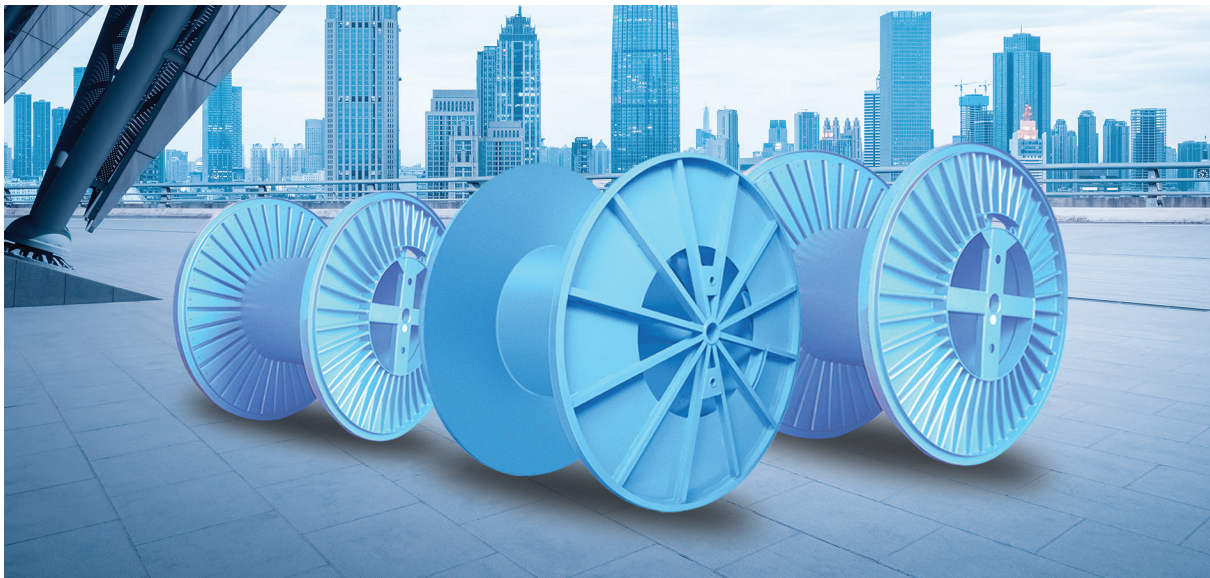

- ▶ 25%-30% cost of steel cable drum can be recovered by scrapping as compared to wooden drums.
- ▶ Steel cable drums are weather proof.
- ▶ Steel cable drums are also more solid as compared to wooden drums.

# EASY ASSEMBLE

## Customization Options

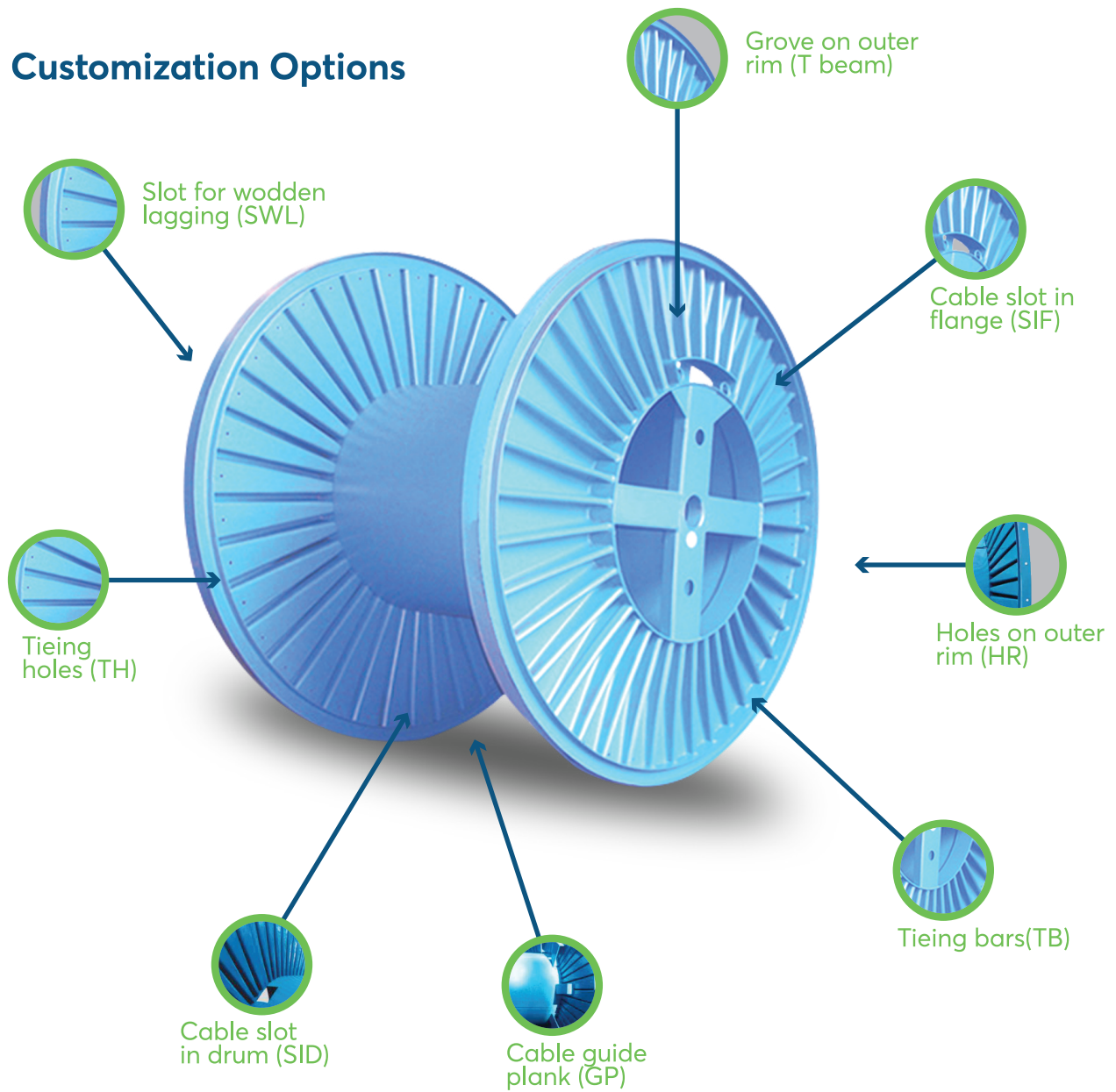

## Easy Assembly

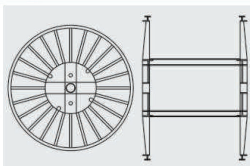
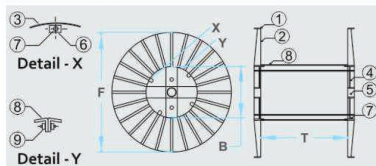
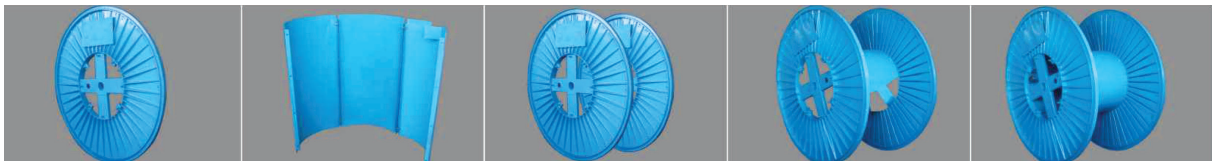

1. Outer Ring
  2. Corrugated Sheet
  3. Inner Ring
  4. Cross Arm
  5. Centre Hub
  6. Tierod Holder
  7. Tierod with Nut, Washer
  8. Barrel Sheet
  9. Hox Bolt, Nut, Washer & Spring
- F: Flange Dia  
B: Barrel Dia  
T: Traverse



\*Ordering Fromat: Flange Dia.(F) x Barrel Dia.(B) x Traverse(T)

# WOODEN REELS & PALLETS



Mixed Hard Wood /  
Soft Wood



Flange Ø 600mm  
to 3,600mm



Wire and cable  
rope packing



## Hybrid Reel



Mild Steel /  
Soft Wood



Flange Ø 1,600mm  
to 2,500mm



Cable packing. It captures a higher loading  
capacity compared to wooden reels



## Pallets and Crates

Aiming to satisfy our prestigious customers, optimally, we present our customers with a quality assured and top class assortment of Wooden Pallet and Crates. Highly appreciated and accepted across the national as well as international industry for their sturdiness, recyclable nature, superior endurance and excellent finishing, these are highly demanded in the industry.



Mixed Hard Wood /  
Soft Wood



Rectangular  
& Square



Material



Sizes



Loading Weight



Ideal for

# ENVIRONMENT PLEDGE



Apex Engineering has always been a part of the Green Initiative to reduce cutting trees and against the usage of natural environment. We strongly believe in repair, reuse and recycling. We use steel instead of wood to manufacture drums/reels for cable packaging. We are not just earth friendly but we also want to preserve it and most importantly grow trees as many as possible.

Apex Engineering has a very helpful reel/drum reuse programme for cable/conductor industries. We have dedicated staff and labour to repair existing inventory of our reel/drum buyers and transport it back to their works hassle free. Also, Apex Engineering can manufacture new steel cable drums which when used can be transported back to our works for repair and supplied back for reuse again and again to cut costs of our buyers. The whole process would not only save time but also cut costs and we can contribute together towards the green initiative.

Apex Engineering is the only player in the cable packaging industry to provide a complete solution to its buyers which would include the product, its reuse/repair and logistics.



**Regd. Office:** Plot No 11, Silver Soil Industrial Park, Main Jaipur Bikaner Expressway, Near Anatpura. Chomu, Jaipur-303712 Rajasthan INDIA

**Works:** 3/4/7, Dabhan Road, Yogi Ngar, Near Shyam Villa, Nadiad-387002 Gujarat INDIA

**Mail :** [apexengineering,jaipur@gmail.com](mailto:apexengineering,jaipur@gmail.com)

**Call Now:** +91-88246 54850, +91-78787 55594

**Mail:** [info@apexengineeringworks.com](mailto:info@apexengineeringworks.com) **Web:** [apexengineeringworks.com](http://apexengineeringworks.com)

**Marketing Office:** Jaipur | Mumbai | Nadiad (Ahmedabad) | Aurangabad